

NEW!

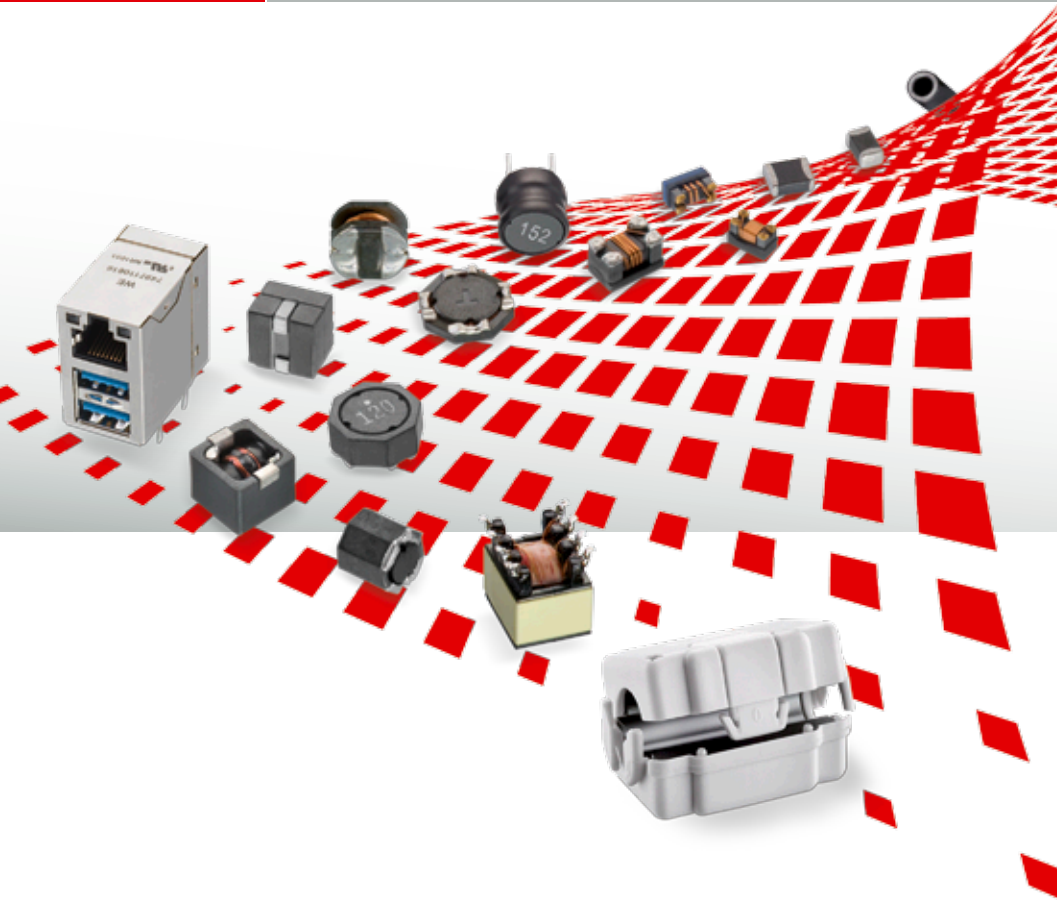

Passive Components

New Products 2010/2011



- EMC Ferrites**
- Common Mode Chokes**
- Power Inductors**
- Power Transformers**
- LAN Transformers**

Small Component – Huge Award

WE-PMI Power Multilayer Inductor

We are proud to achieve the position of 1st place in product of the year 2010 for the “Passive Components“ category, as voted by readers of ELEKTRONIK magazine.



Thanks to all the readers of ELEKTRONIK magazine. The whole Würth Elektronik team feels honoured with this award.

- Compact multilayer
- Suitable for applications with high currents up to 2.5 A
- Magnetically shielded construction: No crosstalk
- For DC/DC converters, especially at high switching frequencies (> 1 MHz)
- For portable devices like PDA and digital cameras



Product of the year 2010!*

Characteristics

- Compact multilayer type
- Suitable for applications with high currents up to 2.5 A
- Magnetically shielded construction: No crosstalk
- Operating temperature: -40 °C to +125 °C
- Recommended soldering profile: Reflow
- Available in two different types

Applications

- DC/DC converters especially at high switching frequencies (> 1 MHz)
- Portable devices like PDA and digital cameras

* Category Passive Components in the magazine ELEKTRONIK

Electrical properties: Size 0805

Order Code	Inductance ±20% (µH)	Q min.	Test Frequency (MHz)	DCR ±30% (mΩ)	I _r @ 20K (mA)	I _r @ 40K (mA)	I _{sat} (mA)	SRF min. (MHz)	Qty.
744 797 752 10	1.0	10	1	90	800	1100	700	100	4000
744 797 752 22	2.2	12		270	500	700	500	70	

I_s referring to self-heating, I_u referring to inductance loss of 30%

Inductance vs. Current

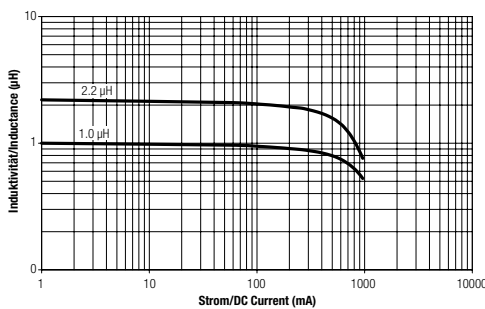

Dimensions (in mm)

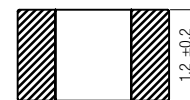
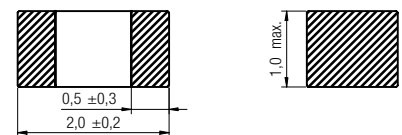

Land pattern (in mm)

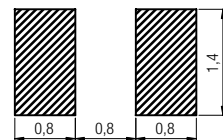

Electrical properties: Size 0806

Order Code	Inductance ±20% (µH)	Q min.	Test Frequency (MHz)	DCR ±30% (mΩ)	I _r @ 20K (mA)	I _r @ 40K (mA)	I _{sat} (mA)	SRF min. (MHz)	Qty.
744 797 762 22	2.2	15	1	110	900	1200	400	75	3000
744 797 762 33	3.3			130	800	1100	300	60	
744 797 762 47	4.7			160	700	1000	250	45	

I_s referring to self-heating, I_u referring to inductance loss of 30%

Inductance vs. Current

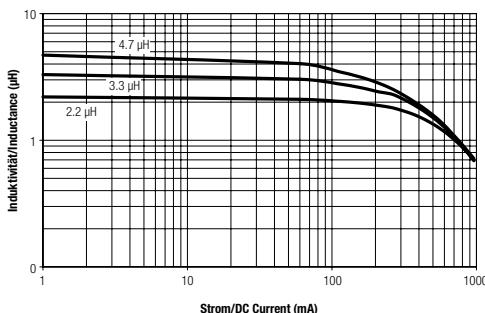

Dimensions (in mm)

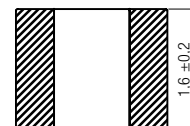
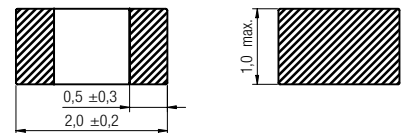

Land pattern (in mm)

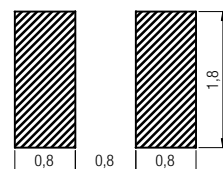

Power Multilayer Inductor

Size 1008 (Low DCR) / Size 1008 (High Current)

Electrical properties: Size 1008 (Low DCR)

Order Code	Inductance $\pm 20\%$ (μH)	Q min.	Test Frequency (MHz)	DCR $\pm 30\%$ (m Ω)	I_R @ 20K (mA)	I_R @ 40K (mA)	I_{sat} (mA)	SRF min. (MHz)	Qty.
744 797 871 47	0.47	15	1	90	1500	1900	700	110	3000
744 797 872 10	1.0	15		120	2000	2500	500	90	
744 797 872 15	1.5	15		70	1200	1600	800	70	
744 797 872 22	2.2	15		80	1100	1500	700	60	
744 797 872 33	3.3	20		100	950	1350	400	50	
744 797 872 47	4.7	20		110	850	1250	250	40	

I_R referring to self-heating, I_{sat} referring to inductance loss of 30%

Inductance vs. Current

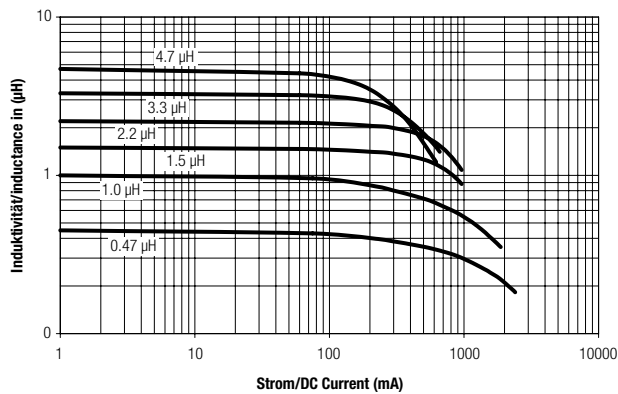

Dimensions (in mm)

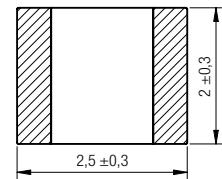
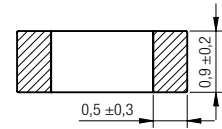

Land pattern (in mm)

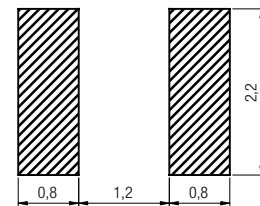

Electrical properties: Size 1008 (High Current)

Order Code	Inductance $\pm 20\%$ (μH)	Q min.	Test Frequency (MHz)	DCR $\pm 30\%$ (m Ω)	I_R @ 20K (mA)	I_R @ 40K (mA)	I_{sat} (mA)	SRF min. (MHz)	Qty.
744 798 872 10	1.0	15	1	290	600	1000	1200	100	3000
744 798 872 22	2.2	19		400	550	850	1100	70	
744 798 872 47	4.7	26		530	450	750	850	50	
744 798 872 68	6.8	30		650	350	700	600	40	
744 798 873 10	10	35		700	300	650	350	30	

I_R referring to self-heating, I_{sat} referring to inductance loss of 30%

Inductance vs. Current

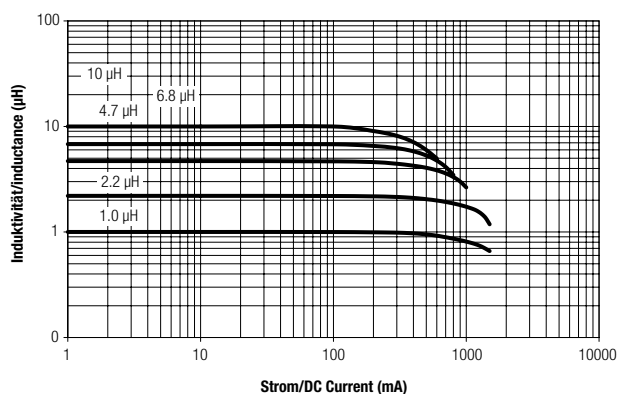

Dimensions (in mm)

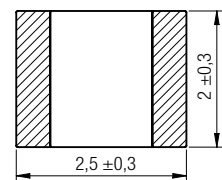
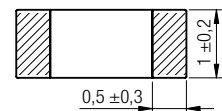

Land pattern (in mm)

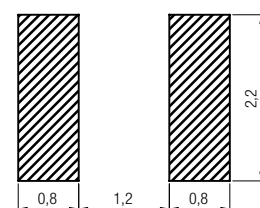

STAR-BUENO Snap Ferrite

With optical closing control mechanism



Characteristics

- Internal prefixing cable system facilitates the cable assembling process
- The security lock guarantees electromagnetic compatibility because only authorized persons can unlock the snap ferrite with the STAR-TEC key
- Classification of the plastic case: UL94-V0
- Operating temperature: $-25\text{ }^{\circ}\text{C}$ to $+105\text{ }^{\circ}\text{C}$

Applications

- EMC ferrite for the EMI suppression in the frequency area from 1 MHz to 1 GHz
- Fastening for round cables with diameter 2.5 mm to 8.5 mm or if wound more turns through the ferrite
- Reusable because of the key technology therefore perfect for test and measuring purposes in EMC labs

Electrical properties

Order Code	Impedance (Ω)		Material	Cable \varnothing (mm)
	25 MHz	100 MHz		
742 758 12	100	150	4 W 620	2.5–5.0
742 758 13	120	200		4.5–8.5
742 758 15	180	250		4.5–8.5

Dimensions 742 758 12 (in mm)

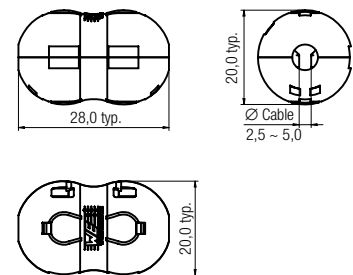

Characteristics of one turn

742 758 12

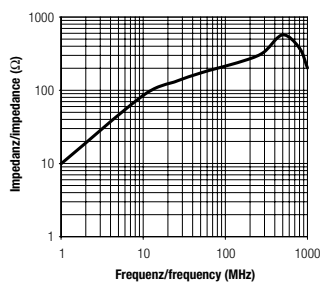

742 758 13

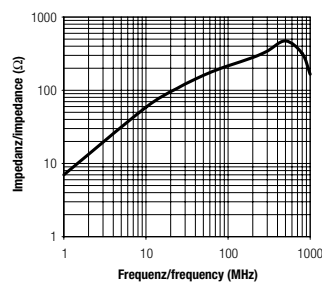

Dimensions 742 758 13 (in mm)

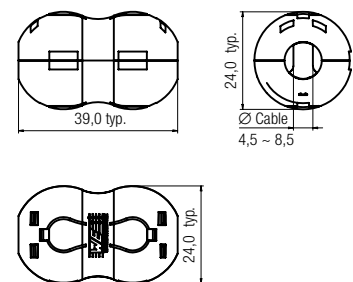

742 758 15

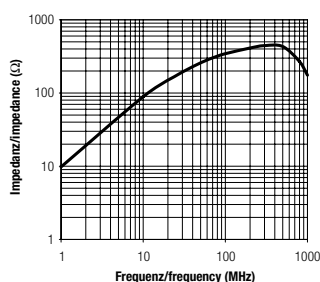

Dimensions 742 758 15 (in mm)

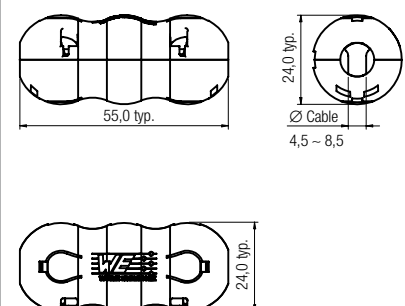

WE-AFB LFS

Low Frequency Axial Ferrite Bead

Suppression in the low frequency range



150 kHz to 30 MHz

Characteristics

- Ferrite core made of MnZn, a material which works in the low frequency range
- Operating temperature: -25 °C to +85 °C

Applications

- Especially for applications in the low frequency range from 150 kHz to 30 MHz
- Suppression of electronic ballasts (i.e. neon tube) in the lighting industry

Electrical properties

Order Code	A (mm)	B (mm)	C (mm)	Impedance (Ω)		Material	Cable Ø ≤ (mm)
				1 Turn			
				1 MHz	10 MHz		
742 772 33	9.5	4.75	9.5	30	40	8 W 5000	4.4
742 772 7	14.2	6.35	28.5	130	100		6.0
742 772 53	16.0	8.0	28.5	100	80		7.6
742 772 9	17.5	9.5	28.5	100	60		9.1
742 772 55	18.6	10.2	28.5	90	60		9.8
742 772 90	26.0	13.0	28.5	90	50		12.5

Sorted according to measurement B

Dimensions

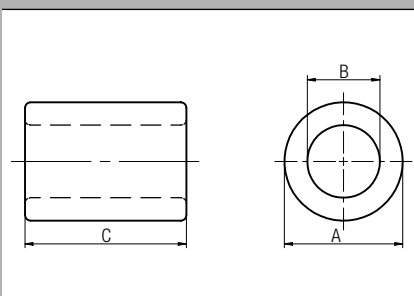

Material characteristics

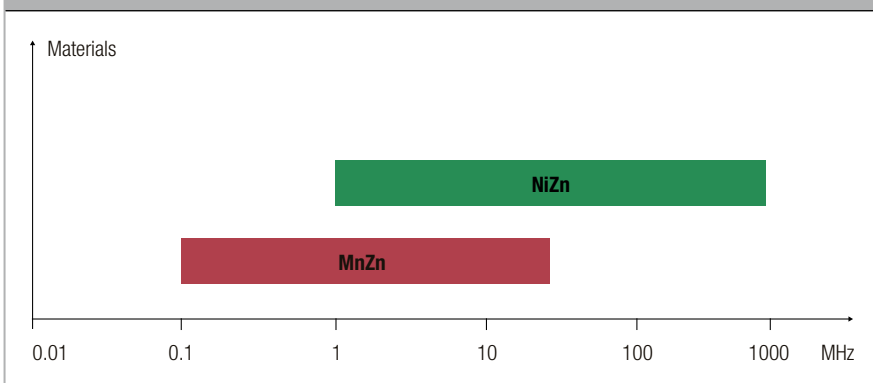

Comparison of core material

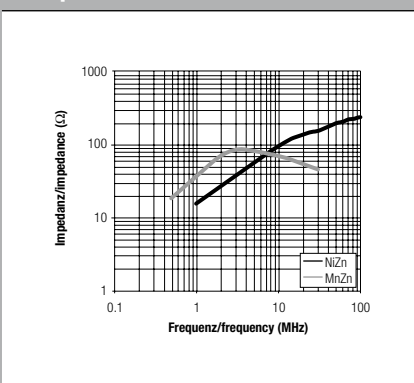

Low Frequency Suppressor Snap Ferrite

Suppression in the low frequency range between 300 kHz to 30 MHz



150 kHz to 30 MHz

Characteristics

- Ferrite core made of MnZn, a material which works in the low frequency range
- Operating temperature: -25 °C to +85 °C

Applications

- Especially for applications in the low frequency range from 150 kHz to 30 MHz
- Perfect for applications with varying cable diameter
- Reusable because of the key technology therefore perfect for test and measuring purposes and cables with difficult access
- Suppression of electronic ballasts (i.e. neon tube) in the lighting industry

Electrical properties

Order Code	A (mm)	B (mm)	C (mm)	Impedance (Ω)		Material	Cable \varnothing (mm)
				1 MHz	10 MHz		
742 727 33	35.1	21.7	18.2	30	45	8 W 5000	4.5-8.0
742 727 22	35.1	31.0	28.0				8.5-12.5

742 71: 5 safety keys

Dimensions

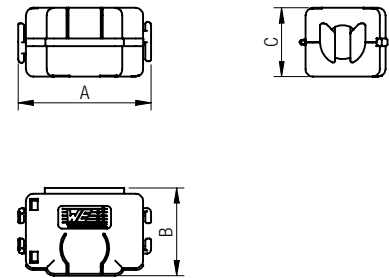

Impedance vs. Frequency

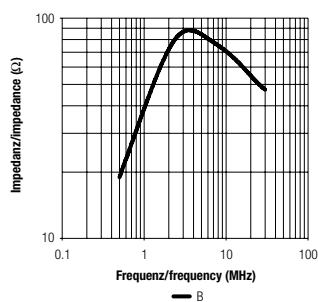

Comparison of core material

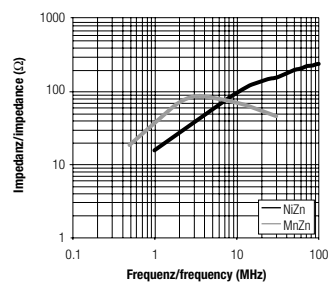

WE-CNSW

SMD Common Mode Line Filter

Size 0603



Characteristics

- High common mode noise suppression at high frequencies
- Small influence on high speed signals through winding symmetry
- Recommended solder profile: Reflow
- Operating temperature: $-40\text{ }^{\circ}\text{C}$ to $+105\text{ }^{\circ}\text{C}$

Applications

- USB 2.0
- IEEE 1394 (Firewire)
- LVDS
- High Speed Data Lines
- Suppression for Common Mode Noise
- LAN

Electrical properties

Order Code	Impedance @ 100 MHz (Ω)	Rated Voltage (V)	DCR (m Ω)	I_r (mA)	Suitable for
744 230 220	22	50	80	800	High Speed Data Lines
744 230 450	45		110	650	High Speed Data Lines
744 230 900	90		145	550	USB 2.0
744 230 121	120		175	450	IEEE 1394 / Firewire 400 Mbps
744 230 181	180		210	400	IEEE 1394 / Firewire 400 Mbps
744 230 251	250		280	350	High Speed Data Lines

Schematic

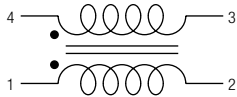

Land pattern (in mm)

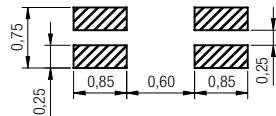

Dimensions (in mm)

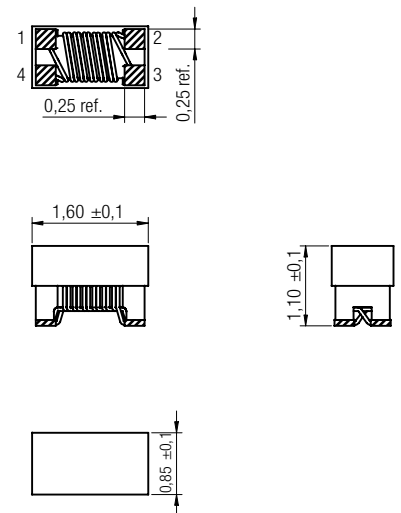

744 230 220

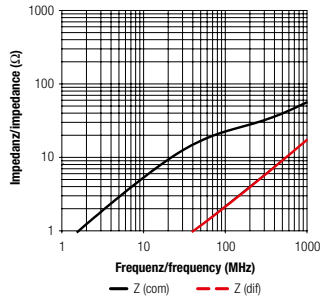

744 230 450

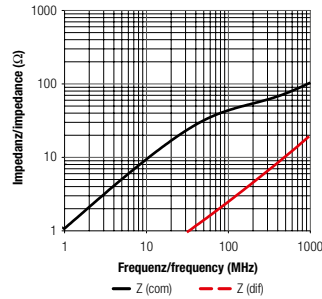

744 230 900

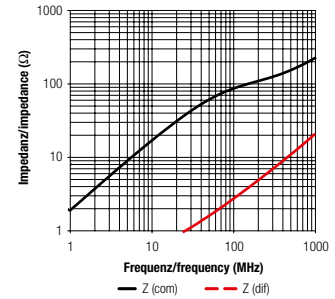

744 230 121

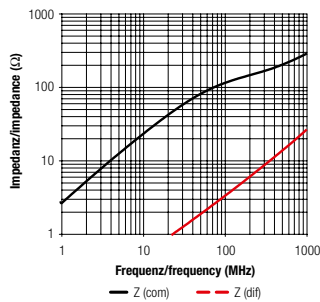

744 230 181

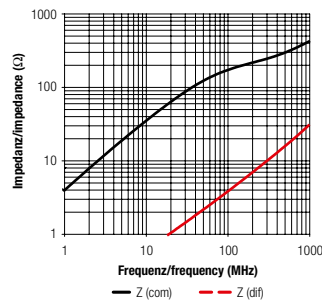

744 230 251

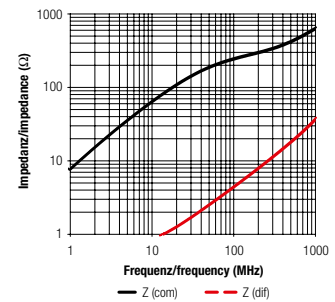

WE-CNSW HF

SMD Common Mode Line Filter

Size 0805



High frequency version

Characteristics

- Current compensated data line filter
- High common mode noise suppression at high frequencies
- Suitable for high data rates
- Small influence on high speed signals through winding symmetry
- Recommended solder profile: Reflow
- Operating temperature: $-40\text{ }^{\circ}\text{C}$ to $+125\text{ }^{\circ}\text{C}$

Applications

- USB 3.0
- USB 2.0
- HDMI
- LVDS
- High-Speed data lines
- IEEE 1394 (Firewire)

Suitable for USB 3.0 applications

Electrical properties

Order Code	Impedance @ 100 MHz (Ω)	Rated Voltage (V)	DCR (m Ω)	I_r (mA)	Suitable for
744 233 670	67	50	240	320	USB 3.0
744 233 900	90		300	280	HDMI
744 233 121	120		300	280	LVDS / USB 2.0

Dimensions (in mm)

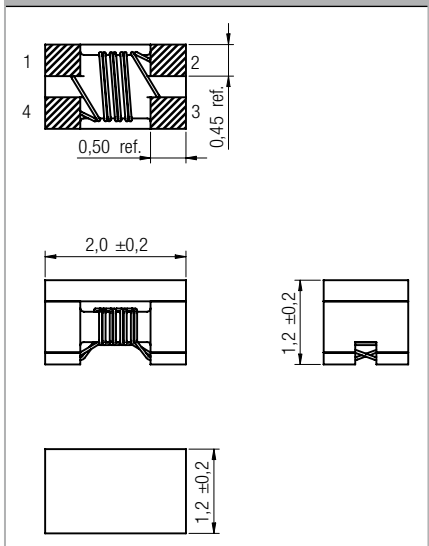

Schematic

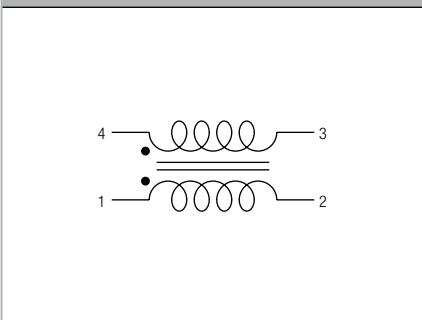

Land pattern (in mm)

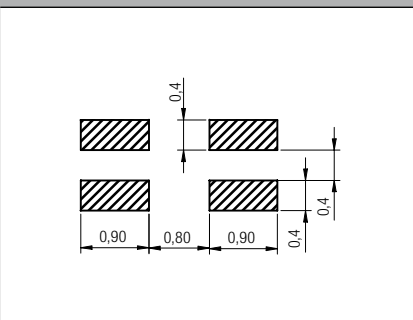

744 233 670

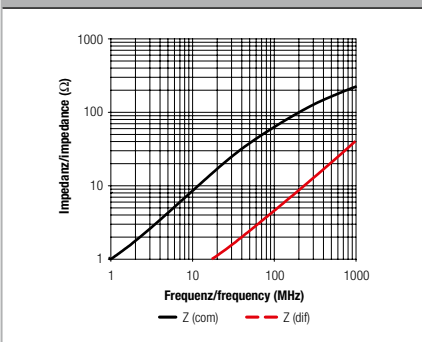

744 233 900

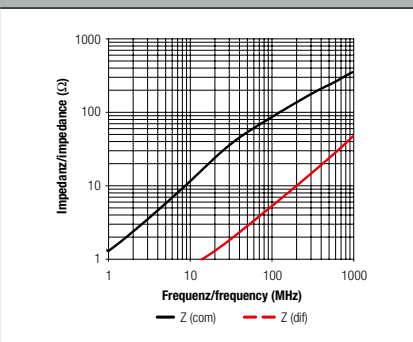

744 233 121

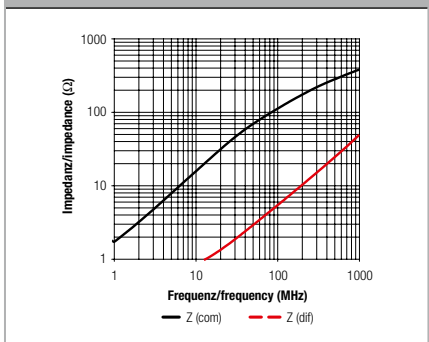



Small package size!

Extremely high saturation current!

Characteristics

- Flat power inductor 2.8 x 2.8 x 2.8 mm
- High current capability up to 4.7 A
- Magnetically shielded which results in a low leakage field
- Recommended solder profile: Reflow
- Operating temperature: -40 °C to +125 °C

Applications

- Portable power like PDA, digital camera, PCMCIA cards and displays
- DC/DC converter
- Embedded PC
- Mobile data gathering, telemetric

Electrical properties

Order Code	Inductance (µH)	Tolerance (%)	DCR typ. (mΩ)	DCR max. (mΩ)	I _r (A)	I _{sat} (A)	Qty.
744 025 000 47	0.47	±25	19.0	23.0	3.30	4.70	550
744 025 000 72	0.72	±25	23.5	27.5	3.00	4.00	
744 025 001	1.20	±20	36.0	42.0	2.60	3.00	
744 025 002	2.20	±20	57.0	66.0	1.80	2.40	
744 025 003	3.30	±20	85.0	101	1.50	1.80	
744 025 004	4.70	±20	100	120	1.35	1.70	
744 025 006	6.80	±20	142	165	1.10	1.30	
744 025 100	10.0	±20	170	190	1.00	1.10	
744 025 150	15.0	±20	356	400	0.72	0.90	
744 025 220	22.0	±20	525	575	0.50	0.75	

I_r referring to 40 K self-heating above ambient temperature
 I_{sat} referring to inductance loss of 35% typ.

Dimensions (in mm)

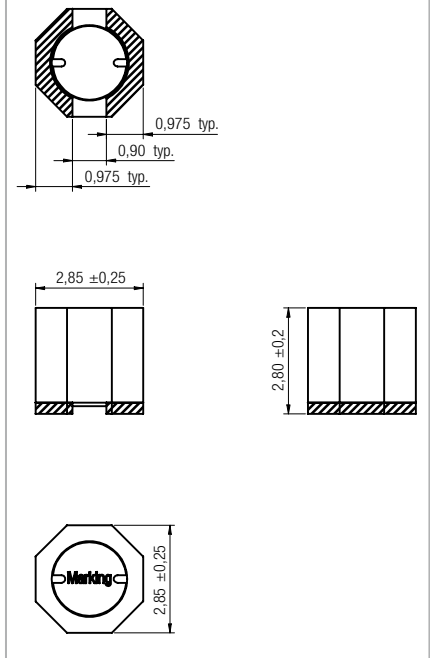

Inductance vs. Current

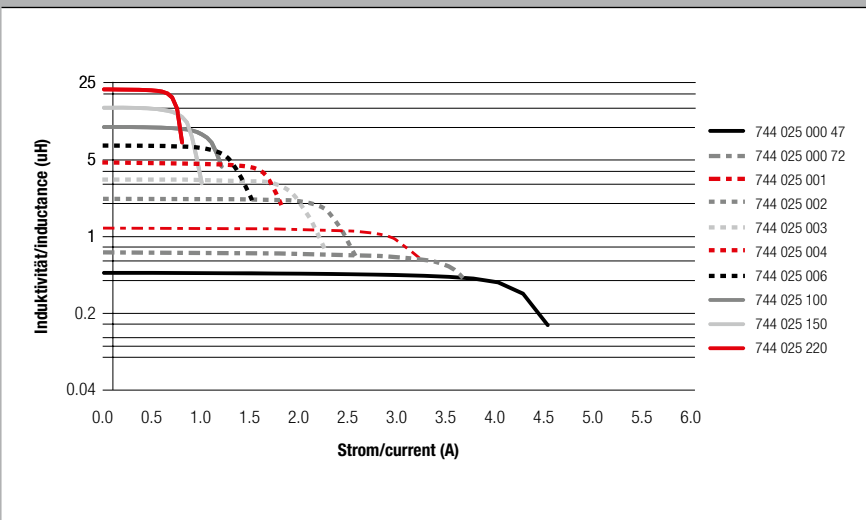

Land pattern (in mm)

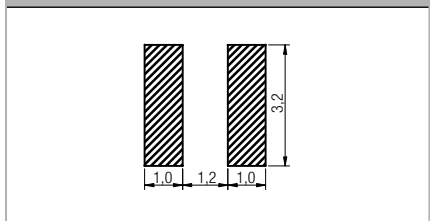

WE-TDC SMD Coupled Inductor

Size 8018



Height 1.8 mm and currents up to 14 A

Characteristics

- Core material: NiZn
- Low profile
- Magnetical shielded which results in a low leakage field
- 8x8 mm case
- 1:1 transformer
- Low self-losses
- High self resonance frequency
- Coupled inductor with two identical windings
- Recommended solder profile: Reflow
- Operating temperature: -40 °C up to +125 °C

Applications

- Non-isolated flyback converter
- Buck or Boost with AUX winding
- BUCK-BOOST, SEPIC, ZETA & CUK Converter
- Switching regulators with secondary unregulated output voltages

Electrical properties

Order Code	Inductance (µH)	DCR typ. (mΩ)	DCR max. (mΩ)	I _r max. (A)	I _{sat} typ. (A)	SRF (MHz)	Qty.
744 894 300 033	0.33	11.1	15.0	4.00	9.00	280	550
744 894 300 068	0.68	16.3	21.0	3.30	6.50	190	
744 894 300 10	1.00	22.2	28.0	2.85	5.10	136	
744 894 300 22	2.20	49.5	58.0	1.90	3.50	85	
744 894 300 27	2.70	69.5	80.5	1.85	3.00	65	
744 894 300 39	3.90	82.0	94.0	1.60	2.55	60	
744 894 300 56	5.60	114	131	1.45	2.20	50	
744 894 300 68	6.80	128	146	1.25	2.00	46	
744 894 301 00	10.0	190	215	1.00	1.65	35	
744 894 301 20	12.0	202	227	0.95	1.55	33	
744 894 301 50	15.0	275	308	0.85	1.25	29	
744 894 301 80	18.0	345	380	0.80	1.20	27	
744 894 302 20	22.0	435	480	0.70	1.10	17	

I_r 40 K over ambient temperature when both windings in series are energized by rated current mentioned.
I_{sat} inductance drop of 10% typ when energizing one winding by I_{sat} mentioned.

Dimensions (in mm)

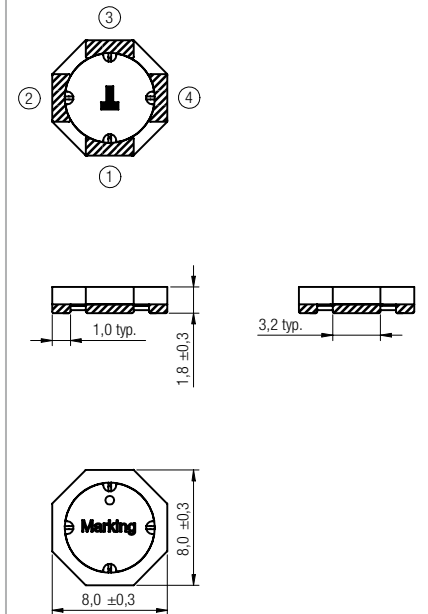

Inductance vs. Current

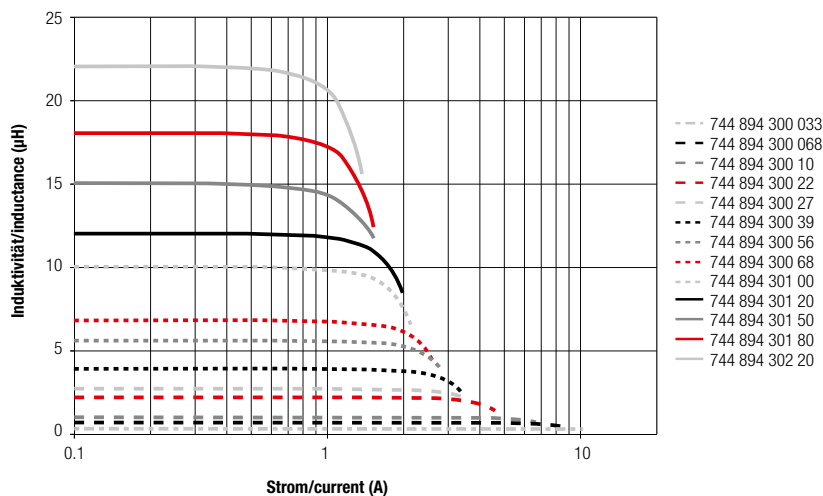

Land pattern (in mm)

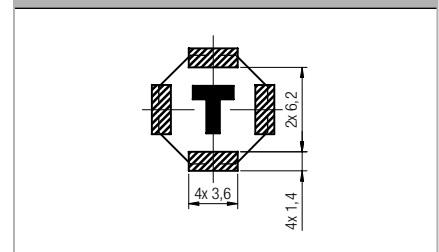

Schematic

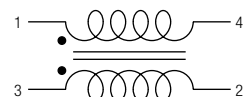

WE-TDC

SMD Coupled Inductor

Size 8038

Electrical properties							
Order Code	Inductance (µH)	DCR typ. (mΩ)	DCR max. (mΩ)	I _R max. (A)	I _{sat} typ. (A)	SRF (MHz)	Qty.
744 894 400 039	0.39	11.6	14.5	4.50	14.0	210	350
744 894 400 082	0.82	15.9	20.0	3.70	9.60	140	
744 894 400 12	1.20	20.2	26.0	3.05	7.50	90	
744 894 400 18	1.80	25.5	31.0	2.85	5.80	60	
744 894 400 47	4.70	54.5	64.0	1.85	4.20	30	
744 894 400 68	6.80	88.0	100	1.45	3.20	25	
744 894 401 00	10.0	113	128	1.35	2.60	23	
744 894 401 20	12.0	117	132	1.30	2.30	20	
744 894 401 50	15.0	165	185	1.10	2.20	17	
744 894 401 80	18.0	179	201	1.05	1.90	15	
744 894 402 20	22.0	203	228	1.00	1.80	14	

I_R of 40 K over ambient temperature when both windings in series are energized by rated current mentioned.
 I_{sat} inductance drop of 10% typ when energizing one winding by I_{sat} mentioned.

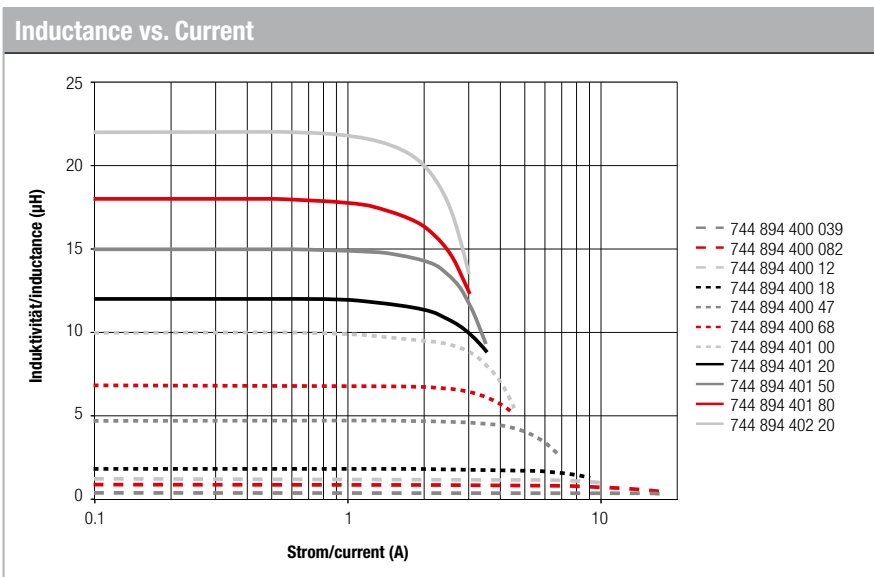
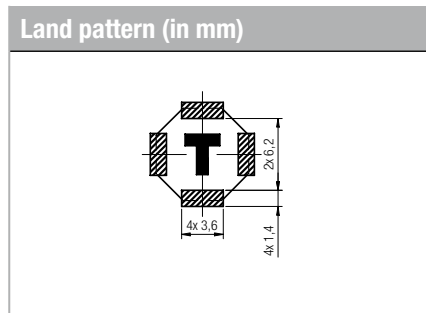
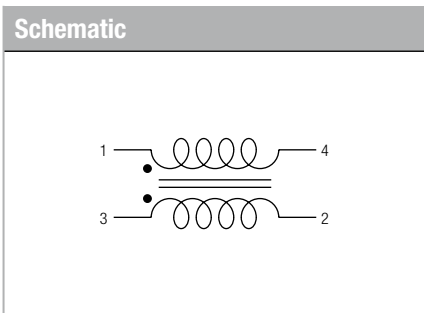
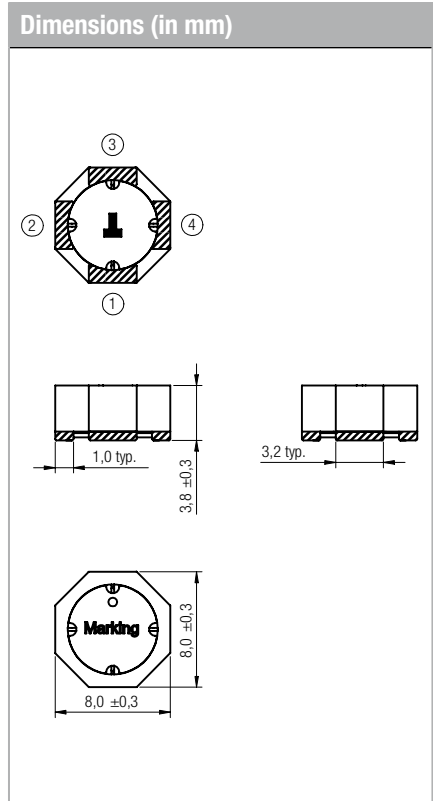

WE-PD2 HV

High Voltage SMD Power Inductor

Size 7850 / Size 1054



**Inductors for non-isolated SMPS
(400 V_{DC})**

Characteristics

- Unshielded construction
- Designed for 400 V_{DC}
- Recommended solder profile: Reflow
- Operating temperature: -40 °C to +125 °C

Applications

- Non-isolated buck or buck-boost converter like Power Integrations LinkSwitch-TN
- Constant current LED driver
- Utility metering
- Filter for power supply

Electrical properties: Size 7850

Order Code	Inductance (μH)	DCR typ. (Ω)	DCR max. (Ω)	I _R (A)	I _{sat} (A)	Qty.
768 775 30	1000	2.78	3.3	0.30	0.30	500
768 775 312	1200	3.77	4.5	0.28	0.28	
768 775 322	2200	6.00	7.2	0.15	0.20	

I_R referring to 40 K self-heating above ambient temperature
I_{sat} referring to inductance loss of 10% typ.

Land pattern (in mm)

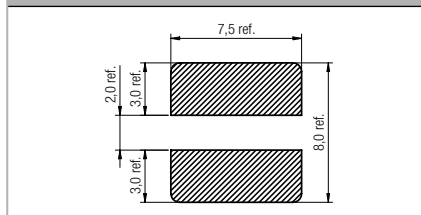

Dimensions (in mm)

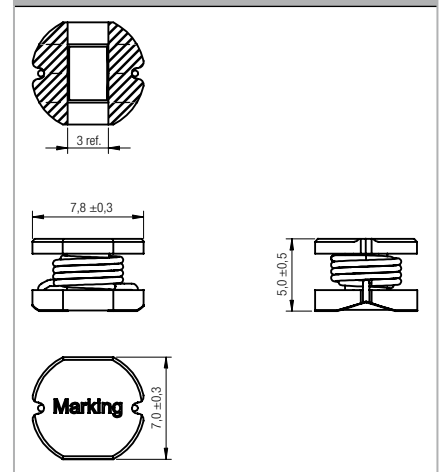

Electrical properties: Size 1054

Order Code	Inductance (μH)	DCR typ. (Ω)	DCR max. (Ω)	I _R (A)	I _{sat} (A)	Qty.
768 776 30	1000	2.20	2.6	0.38	0.38	500
768 776 312	1200	2.48	3.0	0.35	0.35	
768 776 322	2200	4.40	5.3	0.18	0.26	

I_R referring to 40 K self-heating above ambient temperature
I_{sat} referring to inductance loss of 10% typ.

Land pattern (in mm)

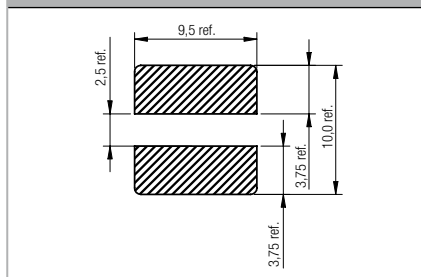

Dimensions (in mm)

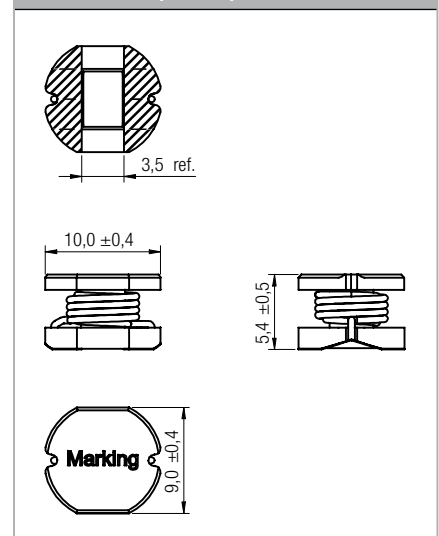

Note

With effect 7th January 2010 the so-called standby regulation came into force within the European Union. Reducing the power consumption until 2020 by 75% in the standby mode is the aim of this regulation. Due to that regulation electrical home appliance, communication and office equipment aren't allowed to spend more than 2 Watt in the standby mode. For devices which are simply reactivated only 1 Watt is allowed. From 2014 on the values will reduce further on. For those standby applications SMPS are needed that are compact and efficient but don't exceed the requested consumption either. The high voltage version of the power inductors WE-PD2 is especially designed for such applications. A special layout combined with a complex test setup guarantees the requested withstand voltage of the rectified supply voltage of 400 V_{DC}.



Characteristics

- Radial through-hole inductor
- High saturation core material
- Unshielded construction
- Designed for 400 V_{DC}

Applications

- Non-isolated buck or buck-boost converter like Power Integrations LinkSwitch-TN
- Constant current LED driver
- Utility metering
- Filter for power supply

**Inductors for non-isolated SMPS
(400 V_{DC})**

Electrical properties

Order Code	Inductance (μH)	DCR max. (Ω)	I _n (A)	I _{sat} (A)	Layout
768 772 102	1000	2.08	0.50	0.55	Standard
768 772 122	1200	2.64	0.40	0.45	
768 772 152	1500	3.00	0.38	0.40	
768 772 182	1800	3.30	0.35	0.38	
768 772 222	2200	4.73	0.32	0.32	

Note

Those kinds of inductors are often used in low cost and component count buck converter solutions. Using a switching power supply is more efficient than using passive droppers, independent of comparing a capacitive or resistive solution. A universal input voltage range can be build, too.

Schematic example*

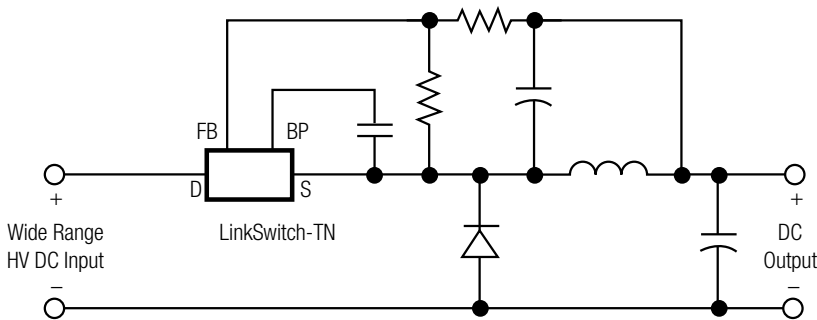

Dimensions (in mm)

Standard

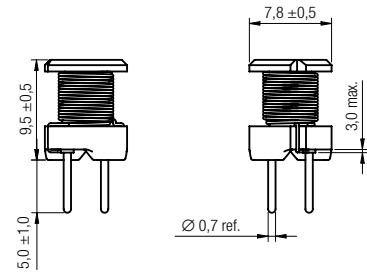
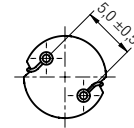

* Source: Power Integrations LinkSwitch-TN

WE-TI

Radial Leaded Wire Wound Inductor

Size LM



Characteristics

- Low profile <8.0 mm
- Rated current up to 7 A
- Saturation current up to 9 A
- Heatshrink Tube for winding protection

Applications

- Signal filtering
- Power supply filter
- EMI filter
- Switching regulators with low operating voltages

High rated and saturation currents in small size

Electrical properties

Order Code	L (μH)	Tolerance (%)	DCR max. (Ω)	I _R (A)	I _{sat} (A)	Type
744 732 015	1.5	±20	0.010	7.00	9.00	Shrink Tube
744 732 100	10	±20	0.033	4.00	4.00	
744 732 470	47	±10	0.14	1.80	1.90	
744 732 121	120	±10	0.38	1.00	1.10	
744 732 221	220	±10	0.70	0.75	1.20	
744 732 331	330	±10	1.20	0.60	1.00	
744 732 471	470	±10	1.70	0.45	0.90	
744 732 681	680	±10	2.20	0.42	0.75	
744 732 102	1000	±10	3.40	0.33	0.60	
744 732 152	1500	±10	4.70	0.29	0.50	

Dimensions (in mm)

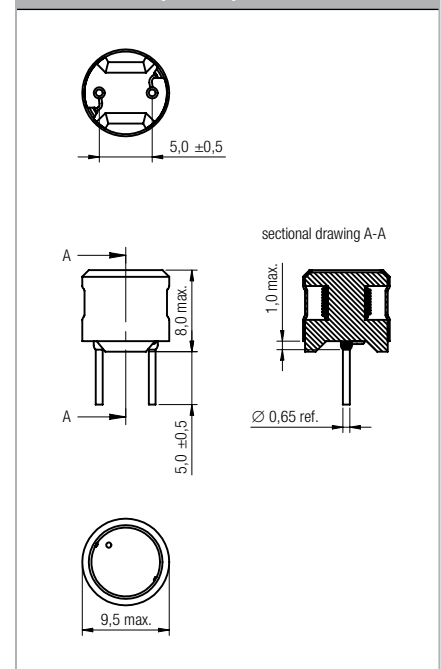

Inductance vs. Frequency

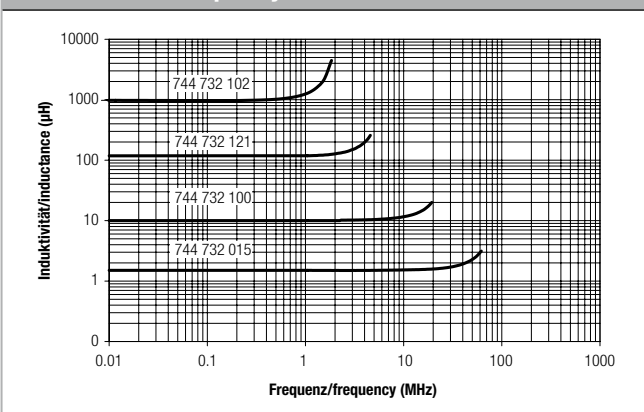

Inductance vs. Current

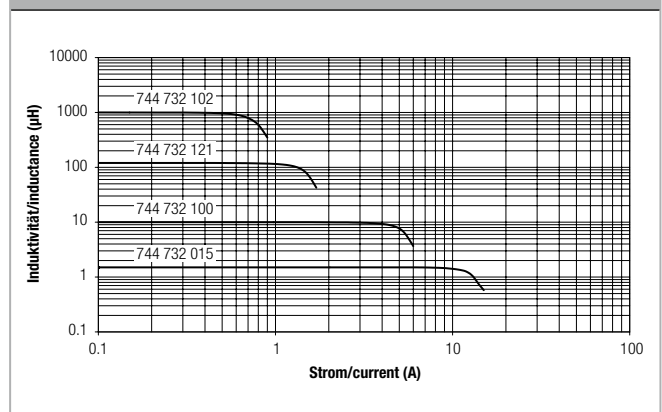

WE-HCF SMD High Current Inductor

Size 2013



Extended inductance values

Characteristics

- Very low core losses (MnZn)
- Recommended solder profile: Reflow
- Operating temperature: -40 °C to +125 °C

Applications

- Storage inductor for high efficiency DC/DC converters
- Single and polyphase buck converters
- Filter for audio applications
- Optimized for high current boost applications

Electrical properties

Order Code	$L_0 \pm 15\%$ (μH)	L_N (μH)	DCR $\pm 10\%$ ($\text{m}\Omega$)	I_R (A)	I_{sat} (A)	Core Material	Qty.
744 363 150 0	15	14.70	8.70	14	21.0	MnZn	100
744 363 220 0	22	21.10	10.65	12	15.0		
744 363 330 0	33	19.40	11.40	12	11.0		
744 363 470 0	47	12.45	12.20	12	8.5		

I_R referring to 50 K self-heating above ambient temperature
 L_N referring to inductance loss of 30%

Dimensions (in mm)

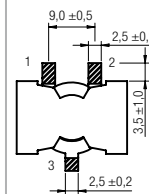

Pad 3 only for mechanical reasons – no center top function

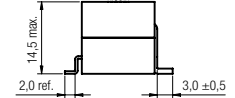
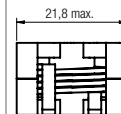

Schematic



Land pattern (in mm)

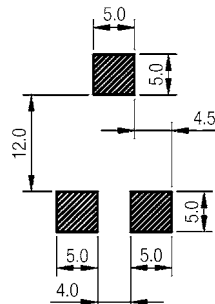

Inductance vs. Current

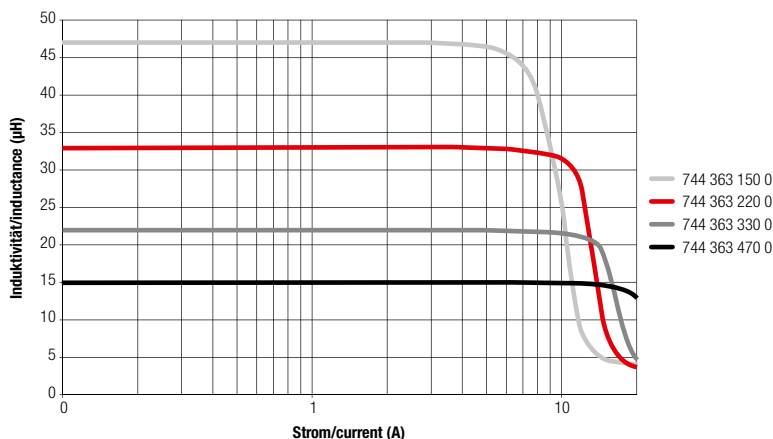

WE-HCM

SMD High Current Flat Wire Inductor

Size 1190 / Size 1390

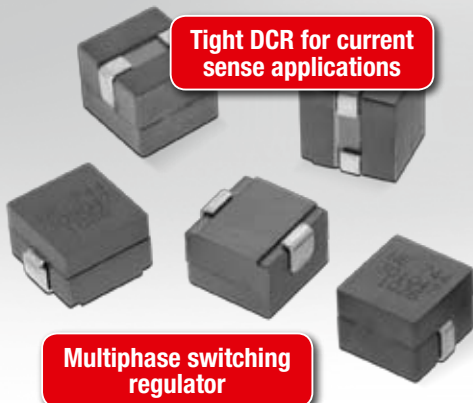

Characteristics

- Low core losses (MnZn)
- High saturation current up to 81 A
- DCR tolerance $\pm 7\%$
- Recommended solder profile: Reflow
- Operating temperature: $-40\text{ }^{\circ}\text{C}$ to $+125\text{ }^{\circ}\text{C}$

Applications

- Multiphase switching regulator
- CPU/Ram power supply
- Power PC
- Input/output filter

Electrical properties: Size 1190

Order Code	$L_o \pm 20\%$ (nH)	DCR $\pm 7\%$ (m Ω)	I_r typ. (A)	I_{sat} typ. (A)	Core Material	Qty.
744 301 025	250	0.32	40	65	MnZn	300
744 301 033	330			46		
744 301 047	470			35		

I_r referring to 50 K self-heating above ambient temperature
 L_o referring to inductance loss of 20%

Land pattern (in mm)

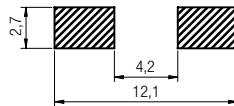

Dimensions (in mm)

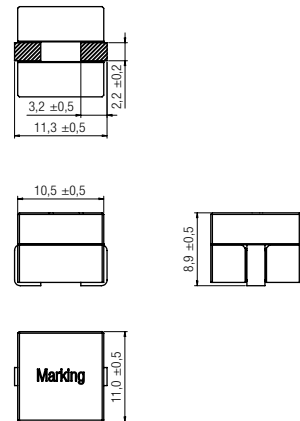

Electrical properties: Size 1390

Order Code	$L_o \pm 20\%$ (nH)	DCR $\pm 7\%$ (m Ω)	I_r typ. (A)	I_{sat} typ. (A)	Core Material	Qty.
744 309 025	250	0.165	50	81.0	MnZn	300
744 309 033	330			62.5		
744 309 047	470			40.5		

I_r referring to 50 K self-heating above ambient temperature
 L_o referring to inductance loss of 20%

Land pattern (in mm)

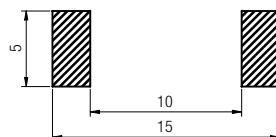

Dimensions (in mm)

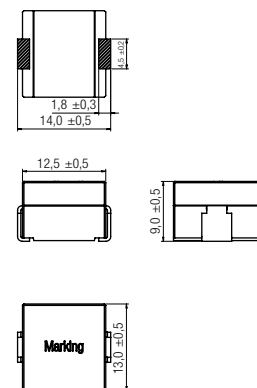

WE-RJ45 LAN

RJ45 LAN Transformer & USB 3.0



Characteristics

- RJ45 Connector with integrated transformer & 2x USB 3.0 & LEDs
- Extended temperature range: -40 °C bis +85 °C
- 10/100/1000BaseT

Applications

- Ethernet, 1 Gigabit Ethernet
- Embedded PC
- Hubs, Router, Switch
- USB 3.0

Typical electrical characteristics

Order Code	749 711 061 6	
Inductance	350 μ H	100 kH, 100 mV, 8 mA _{DC}
Dielectric Rating	1.5 kV _{RMS}	1 Minute
Turns Ratio	1:1	3%
Insertion Loss	-1.0 dB max.	1 MHz – 100 MHz
Return Loss	-16 dB min.	1 MHz – 30 MHz
	-13.5 dB min.	30 MHz – 60 MHz
	-12 dB min.	60 MHz – 80 MHz
	-10 dB min.	80 MHz – 100 MHz
Crosstalk	-30 dB min.	1 MHz – 100 MHz
Common Mode Rejection	-30 dB min.	1 MHz – 100 MHz

Dimensions (in mm)

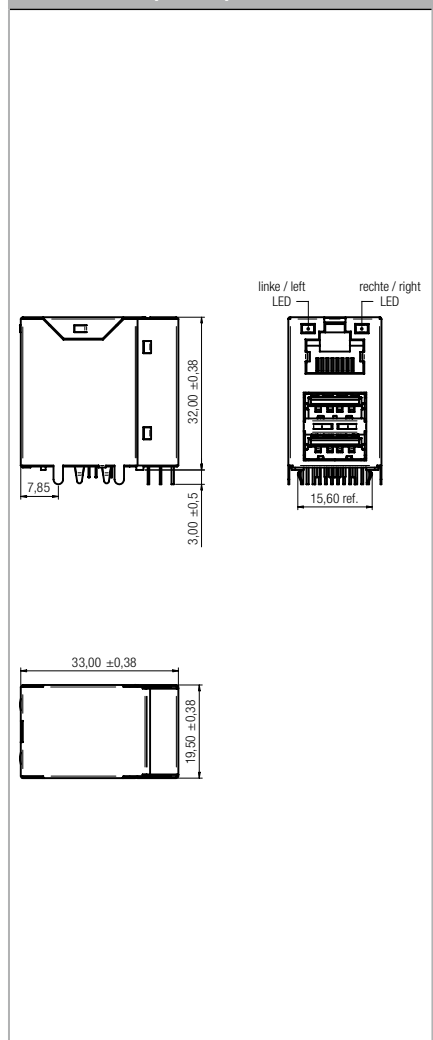

Schematic

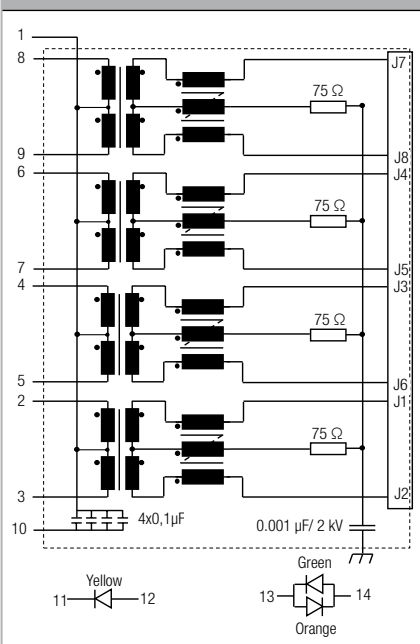

Land pattern (in mm)

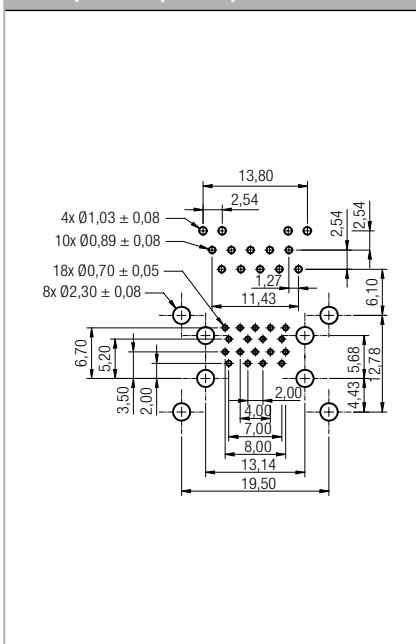

WE-FB

Flyback Transformer

LT3573 / LT3574 / LT3575 / LT3748



Characteristics

- Standard transformers for various output voltages/ currents available
- Easy design of custom power supply due to standard circuit and change of transformers and two components for feedback loop
- Isolation voltage up to 2.5 kV

Applications

- Isolated power design
- Sensor interfaces
- Isolated telecom converters
- High power "Automotive"* supplies
- Power over Ethernet

More design support notes to download on www.we-online.com/LT

* not AECQ 200 tested & approved

Assembled demo boards with option to change included transformer

Order Code**	LT IC	Demoboard	Power (W)	Transformer assembled on board		Transformer 2***		Transformer 3***	
				Order Code	Output Voltage	Order Code	Output Voltage	Order Code	Output Voltage
750 105	LT3574	DC1636A	2.5	750 370 041	5 V / 0.35 A	750 311 304	3.3 V / 0.7 A	750 310 799	12 V / 0.15 A
750 103	LT3573	DC1228A	7	750 370 047	5 V / 1 A	–	–	–	–
750 106	LT3575	DC1643A	10	750 311 675	5 V / 1.4 A	750 310 564	12 V / 0.5 A	750 310 559	3.3 V / 1.5 A
750 107	LT3748	DC1557A	12	750 311 439	12 V / 1 A	750 310 688	3.3 V / 4 A	750 311 689	5 V / 3 A
750 108	LT3748	DC1694A	30	750 311 607	12 V / 2.5 A	750 311 599	15 V / 2 A	750 311 608	24 V / 1.3 A

** all datasheets are available on www.we-online.com

*** different set-ups possible with additional transformers which are included in the design kits

Electrical properties* (sorted by power)

Reference to Linear Technology Specification				All possible OFF THE SHELF transformer										
up to 3 W	up to 7 W	up to 14 W	external MOSFET	WE Order Code	Power (W)	Core	U _{in} (V)	U _{out} (V)	I _{out} (A)	Turns ratio NP:NS	L _{pri} (µH)	Leakage (nH)	Isolation (V)	I _{sat} (A)
			LT3748	750 311 691	< 10	EP5	8-15	150	0.001	5:1	60	1000	1500	0.25
	LT3573			750 310 799	< 10	EP7	18-30	15.0	0.4	1:1	25	125	1500	2.0
LT3574	LT3573			750 370 040	< 10	EP7	18-30	5.0	1.0	3:1	30	200	1500	1.7
LT3574	LT3573			750 370 041	< 10	EP7	18-30	5.0	1.0	3:1	50	450	1500	1.6
LT3574	LT3573			750 370 047	< 10	EP7	18-30	5.0	1.0	3:1	30	150	1500	1.7
	LT3573			750 370 058	< 10	EP7	18-30	15.0	0.4	1:1	25	185	1500	2.0
	LT3573			750 370 059	< 10	EP7	18-30	5.0	1.0	3:1	50	500	1500	1.6
			LT3748	750 311 692	< 10	EP7	8-15	±150	0.001	5:1	80	2000	1500	1.0
	LT3573			750 370 042	< 10	ER9.5	5	5.0	0.2	1:1	15	250	1500	1.5
	LT3573	LT3575		750 310 471	< 10	EP10	9-30	5.0	1.0	3:1	25	430	1500	2.6
	LT3573	LT3575		750 310 559	< 10	EP10	12-30	3.3	1.3	4:1	24	500	1500	2.1
	LT3573	LT3575		750 310 562	< 10	EP10	18-30	12.0	0.5	2:1	25	500	1500	2.8
	LT3573	LT3575		750 310 563	< 10	EP10	18-30	12.0	0.4	2:1	25	500	1500	2.8
LT3574	LT3573	LT3575		750 310 564	< 10	EP10	12-30	±5.0	1.0	3:1	63	600	1500	-
			LT3748	750 311 486	< 10	EP13	12	±200	0.002	1:10	100	4500	1500	2.0
			LT3748	750 811 048	< 10	EE16	100-400	30	0.30	4.387:1	1500	14000	IEC61558-2-12	0.65
			LT3748	750 311 889	< 10	EFD25	28	250	0.1	1:5	37	160	500	2.95
		LT3575		750 311 303	10-15	EP10	9-30	5.0	3.0	5:1	50	800	1500	2.25
LT3574		LT3575		750 311 304	10-15	EP10	9-30	5.0	3.0	4:1	50	850	1500	2.5
		LT3575		750 311 305	10-15	EP10	9-30	12.0	1.0	3:1	50	1200	1500	2.8
		LT3575		750 311 306	10-15	EP10	9-30	12.0	1.0	3:1	100	1750	1500	1.65
LT3574		LT3575		750 311 307	10-15	EP10	9-30	24.0	0.5	2:1	100	2000	1500	1.9
LT3574		LT3575		750 311 308	10-15	EP10	9-30	24.0	0.5	1:1	100	2100	1500	2.1
	LT3573	LT3575	LT3748	750 311 675	10-15	EP10	9-30	5.0	2.0	3:1	25.0	130	1500	2.5
		LT3575	LT3748	750 311 567	10-15	EP10	10-40	5.0	3.0	2:1	7.0	800	1500	11.2
			LT3748	750 311 424	10-15	EP13	36	12.0	1.0	3:1	100	900	1500	2.4
			LT3748	750 311 456	10-15	EP13	36	12.0	1.0	3:1	100	900	2500	2.4
		LT3575	LT3748	750 311 458	10-15	EP13	36	3.3	4.0	3:1	15.0	175	2500	5.0
		LT3575	LT3748	750 311 564	10-15	EP13	10-40	5.0	3.0	3:1	9.07	120	1500	8.0
		LT3575	LT3748	750 311 624	10-15	EP13	10-40	15.0	1.0	1.5:1	9.0	180	1500	>8.0
		LT3575	LT3748	750 311 625	10-15	EP13	10-40	3.3	4.0	4:1	9.0	350	1500	>8.0
		LT3575	LT3748	750 311 856	10-15	EP13	16-24	4 x 15	4x 0.2	1:4:4:4:4	3.8	250	1000	>12
		LT3575		750 311 342	10-15	EFD20	36	5.0	3.0	2:1	15.0	650	1500	5.8
			LT3748	750 311 911	10-15	EE20	16-24	4 x 15	4 x 0.2	1:3:3:3:3	6.8	100	1500	-
		LT3575	LT3748	750 311 422	15-25	EP13	36	5.0	4.0	5:1	50.0	600	1500	3.3
		LT3575	LT3748	750 311 423	15-25	EP13	36	5.0	4.0	2:1	50.0	600	1500	3.85
		LT3575	LT3748	750 311 439	15-25	EP13	37-57	12.0	2.1	2:1	37.0	750	1500	2.8
		LT3575	LT3748	750 311 457	15-25	EP13	36	5.0	4.0	4:1	50.0	600	2500	3.7
		LT3575	LT3748	750 311 688	15-25	EP13	36	5.0	4.0	5:1	50.0	600	1500	3.1
		LT3575	LT3748	750 311 689	15-25	EP13	36	5.0	4.0	4:1	50.0	600	2500	3.7
			LT3748	750 311 385	25-35	EP13	18-60	13.0	2.3	1.25:1	15.0	100	1500	6.75
			LT3748	750 310 617	25-35	EFD20	9-36	12.0	3.0	1:1.16	4.5	150	1500	-
			LT3748	750 311 597	25-35	EFD20	20-48	5.0	6.0	3:1	6.0	300	1500	9.5
			LT3748	750 311 598	25-35	EFD20	20-48	12.0	2.5	2:1	8.3	300	1500	9.0
			LT3748	750 311 599	25-35	EFD20	20-48	15.0	2.0	3:2	8.0	500	1500	12.0
			LT3748	750 311 600	25-35	EFD20	30-75	15.0	2.0	2:1	12.0	500	1500	11.0
			LT3748	750 311 604	25-35	EFD20	20-48	24.0	1.3	1:1	8.0	300	1500	9.5
			LT3748	750 311 605	25-35	EFD20	30-75	5.0	6.0	7:2	15.0	500	1500	9.5
			LT3748	750 311 607	25-35	EFD20	30-75	12.0	2.5	5:2	14.0	500	1500	9.5
			LT3748	750 311 608	25-35	EFD20	30-75	24.0	1.3	3:2	12.0	500	1500	9.0
			LT3748	750 311 797	35-45	EFD20	18-100	12	2.5	2.5:1	14.0	210	4000	11.5
			LT3748	750 311 589	35-45	EFD25	20-48	5.0	9.0	3:1	6.0	200	1500	18.0
			LT3748	750 311 590	35-45	EFD25	20-48	12.0	3.8	2:1	8.0	200	1500	18.0
			LT3748	750 311 591	35-45	EFD25	20-48	15.0	3.0	3:2	8.0	200	1500	20.0
			LT3748	750 311 592	35-45	EFD25	20-48	24.0	1.9	1:1	8.0	200	1500	18.0
			LT3748	750 311 593	35-45	EFD25	30-75	5.0	9.0	7:2	15.0	300	1500	18.0
			LT3748	750 311 594	35-45	EFD25	30-75	12.0	3.8	5:2	15.0	400	1500	18.0
			LT3748	750 311 595	35-45	EFD25	30-75	15.0	3.0	2:1	12.0	200	1500	16.0
			LT3748	750 311 596	35-45	EFD25	30-75	24.0	1.9	3:2	12.0	200	1500	18.0
			LT3748	750 311 771	35-45	EFD25	100-400	15.0	3.0	6:1	500	5000	2500	2.5
			LT3748	750 310 988	35-45	EFD25	12	48.0	0.85	1:4.42	14.0	200	1500	>15
			LT3748	750 311 783	>45	EFD25	19-70	24	2.5	1.5:1	20	170	1500	16

* Dependant on application, the transformer specification can differ slightly to data sheet

Designer Toolbox for purchasers and engineers

WE Inductor Selector

Inductor selector software for SMPS designs:

- Selection of power inductors for SMPS
- For Buck, Boost and Sepic converters
- Intuitive menu
- Offline processable
- Manual calculation alternatively
- Free of charge



TOOLBOX
www.we-online.com/toolbox

WE-FLEX Designer

The WE-FLEX Designer calculates suitable transformers for flyback applications. Free of charge.



Product Finders

With one click you'll find the product you are looking for.

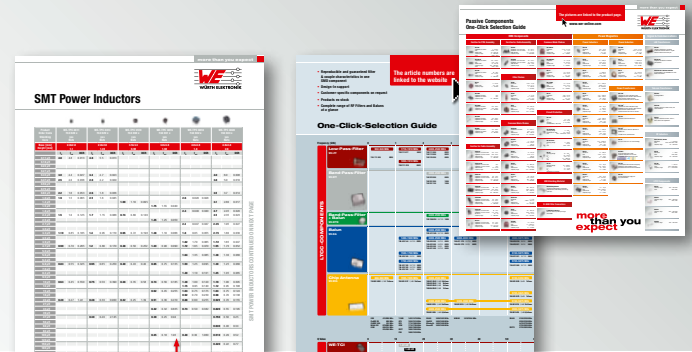

Application Guide

Block diagrams of important applications and interfaces such as:

- DC/DC Converter
- AC/DC Converter
- CAN
- USB
- VGA
- IP Phone
- LCD Monitor
- WLAN
- RS 232/485

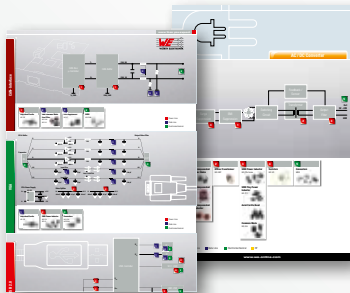

Simulation Software

Simulation tool for the easy selection of suitable switching regulators.

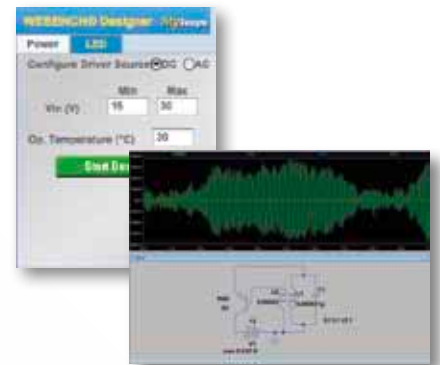

Product Mindmap

Overview of all components related to applications.

All products are linked to the online catalogue, which gives you quick access to all relevant product details and specifications.

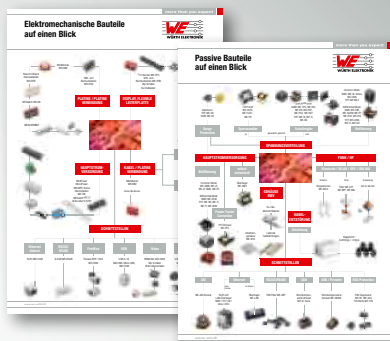

Components Libraries

Component libraries for Eagle and Altium Designer



Product Training

Improve yourself: Use our new product training modules for free. Learn more about how to solve EMI issues with common mode chokes, the key features of high current and flatwire power inductors and their areas of application.



Passive & Electromechanical Components



EMC Components



Power Magnetics



Signal & Communications

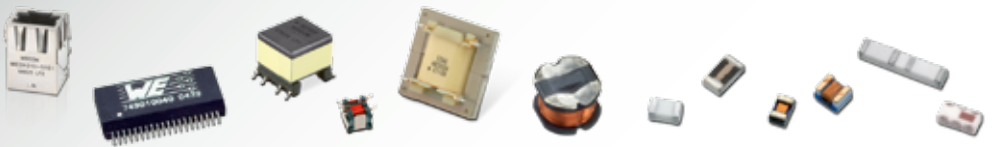

Connectors

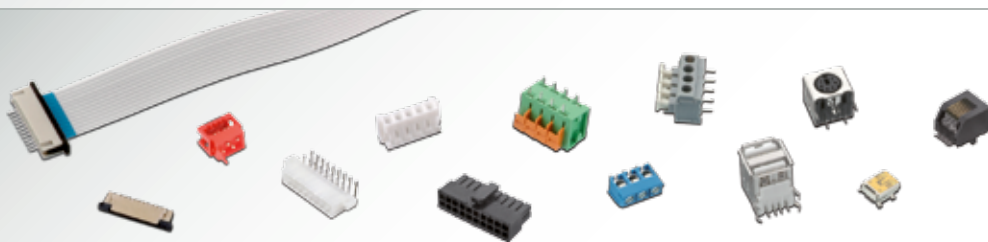

Switches



Assembly Technique



Power Elements



more than you expect

Würth Elektronik differs from all other component manufacturers in several aspects:

- We guarantee all catalogue products are manufactured to stock
- Samples free of charge
- Orders below MOQ
- Design kits with lifelong free refill
- Design Guide Trilogy of Magnetics
- EMC & Power EMI Design Seminars free of charge
- Reference designs of leading IC manufacturers
- Worldwide technical sales force and field application engineers on site
- Custom solutions
- EMC lab search engine

